

Instruction Manual

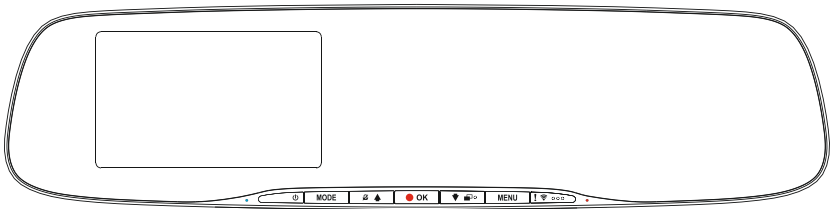

INTRODUCTION TO USING A DASH CAM

The iN-CAR CAM range of Dash Cams have been designed specifically with ease of use in mind, it is recommended NOT to change the default settings, which have been carefully selected to give the best performance for day to day use.

Please check the firmware version of the Dash Cam, the version can be found in the Setup menu under System Info.

The latest versions are available to download from our website, where you can download and update when necessary.

Basic operation.

The Dash Cam is set to record video, in files of just 3 minutes in length. This means that each video file is a manageable size should you need to download and send to your insurance company. Eventually your MicroSD card will fill up with video files but don't worry, the camera automatically deletes the oldest file to make space for new recordings. This way you never run out of space and have plenty of driving historical evidence saved.

Typically a 16Gb card will store the last 120 minutes of driving footage.

The Time and Date are automatically set upon the camera from satellite data, based on the Country selected from within the First Time Use menu.

The Time and Date will also update automatically for Daylight Savings Time, again based on the Country selected.

There are 3 modes of camera operation - Video, Photo and Playback.

Video Mode: The default mode when the camera is turned on, for video recording.

Photo Mode: Allows you to take still photographs.

Playback mode: Allows you to view recorded video or photographs upon the Dash Cam screen. Press the MODE button on the Dash Cam to select required mode.

Automatic Start / Stop Technology. The Dash Cam senses power supplied to the cigarette lighter socket as soon as the vehicle ignition is turned on and will start to record automatically. When the ignition is turned off, the Dash Cam will perform an automatic shutdown process.

INTRODUCTION TO USING A DASH CAM

1. Tips for capturing best video footage:

- 1.1 Reduce the amount of sky in the picture, by angling the view of the camera towards the road. Too much sky will make the road appear darker due to the automatic exposure compensation.
- 1.2 Remove unnecessary items from your dashboard. If objects are placed on your dashboard these can cause reflections to be seen on the windscreen and these reflections may be captured during recording.
- 1.3 To improve dash board glare, a Nextbase Reflection free lens can be purchased.

2. Tips for stable memory card performance:

- 2.1 Periodically reformat the memory card. Every 2-3 weeks we recommend that you reformat the memory card. This will wipe any files from the card and set it up afresh for continued use with your Dash Cam.
Of course, you should only do this AFTER you've downloaded any files from the card that you may want to keep, as formatting the card will remove all content.
- 2.1 Format your memory card using the Dash Cam. This will make sure that the card is structured specifically for your camera. Press MENU twice and choose the Format Card option. Follow the on-screen instructions accordingly.
- 2.2 Switch off the Dash Cam before removing the SD memory card, to prevent the chance of damage being caused to the memory card or the files stored upon it, turn OFF the Dash Cam before removing or inserting the memory card.

TABLE OF CONTENTS

INTRODUCTION TO USING A DASH CAM	02
TABLE OF CONTENTS	04
PRECAUTIONS	05
CAUTIONS ON USING THIS PRODUCT	05
PRODUCT SPECIFICATION	06
PACKAGE CONTENTS	07
PRODUCT FEATURES	07
PARTS & CONTROLS	08
IN VEHICLE INSTALLATION	11
FIRST TIME USE	16
VIDEO MODE	17
PHOTO MODE	23
PLAYBACK MODE	25
SETUP MENU	29
PC CONNECTION	33
Wi-Fi CONNECTION	33
TROUBLE SHOOTING	34

PRECAUTIONS

Please read this manual carefully before operation and keep it for future reference. It will be helpful should you encounter any operational problem.

WARNING: Do not expose this product to rain, moisture or water under any circumstances, doing so may result in the risk of electric shock or fire.

CAUTION: To reduce the risk of electric shock, do not perform any servicing other than that contained in the instruction manual unless you are qualified to do so.

Have the unit serviced by a qualified service technician if;

The Unit has been exposed to rain or water.

The unit does not seem to operate normally.

The unit exhibits a marked change in performance.

CHOKING HAZARD: Some Products may contain components that are small enough to be swallowed.

Please keep out of reach of children.

LCD: A Liquid Crystal Display (LCD) screen is a multilayer complex component, containing 1,152,000 pixels. Pixels can however fail during normal product life. 1 pixel = 0.00009% failure rate, and one pixel failure per year of operation is considered normal and not a cause for concern.

WEEE: Disposal of Waste Electrical and Electronic Equipment and/or Battery by users in private households in the European Union.



This symbol on the product or on the packaging indicates that this cannot be disposed of as household waste. You must dispose of your waste equipment and/or battery by handing it over to the applicable take-back scheme for the recycling of electronic equipment and/or batteries. For more information please contact your local household waste disposal office.

CAUTIONS ON USING THIS PRODUCT

1. Do not obscure the view of the road ahead or impede the deployment of any airbags in the event of an accident.
2. When not in use, please disconnect the car adaptor from both the 12/24Vdc outlet in your vehicle and the device itself.
3. Only clean the device with a soft dry cloth, for tough dirt, apply some neutral detergent diluted in 5 to 6 parts water to a soft cloth.
Note that alcohol, thinner, benzene etc could cause damage to the paint or coatings.
4. Avoid making contact with the Lens as damage may be caused.
5. If required clean the glass lens carefully using spectacle lens cleaning fluid on a soft cloth only.
6. The video recordings made by this Digital Video Recorder are intended for personal use only.
7. Publication of the recordings on Youtube, the internet or other methods are subject to the Data Protection Act and the requirements thereof must be adhered to.
If the Digital Video Recorder is to be used within a commercial environment, i.e. truck use, then the CCTV regulation apply also, in addition to the Data Protection Act regulations. This includes labelling to identify the use of CCTV is taking place, the omission of Audio recording and informing the relevant authorities of who controls the data.
8. Video playback upon the device which is visible to the driver is prohibited or restricted in some countries or States. Please adhere to these laws.
9. Whilst driving, do not adjust the controls of your device as this is a distraction to driving.
10. The LCD Screen Saver should be set to ON, after any initial settings have been adjusted.
This is to ensure that an illuminated LCD panel is NOT a distraction to the driver, whilst driving.

PRODUCT SPECIFICATION

Model Number	NBDVRMIRROR
Power Requirements	5V / 1.5A
Power Supply	12-24Vdc Car Power Cable (supplied) Fuse Type: 20mm / 2A Output: 5Vdc
Sensor Resolution	2.12M Pixel (2,123,792 Pixels)
Lens - Type / Angle / Aperture	6G / 140° / F1.8
Recording Resolution	1920 x 1080 @ 30fps
Screen Size	4.0"
Screen Resolution	800 (W) X 480 (H) pixels x RGB
Card Reader	MicroSD, Class 10, up to 128GB
SD Card (Recommended Type)	8-128GB MicroSD Card, Class 10 (48mb/s), for best results use a recognized brand
SD Card Recorded File Capacity (based on default settings)	8GB MicroSD = 60 minutes of recording 16GB MicroSD = 120 minutes of recording 32GB MicroSD = 240 minutes of recording 64GB MicroSD = 480 minutes of recording 128GB MicroSD = 960 minutes of recording
Recording Format	MOV
Internal Battery	Lithium-ion 3.7V / 800mAh (approx. 20mins recording time) Battery design allows the 'Auto Power Off' feature to function in event of power loss within the vehicle. It is not intended as an alternative power source to replace the supplied car adaptor.
Unit Dimensions	320 x 98 x 42mm
Unit Weight	294g

Android is a trademark of Google Inc. in the United States and other countries.

Mac is a registered trademarks of Apple Inc. in the United States and other countries.

iOS is a trademark or registered trademark of Cisco in the United States and other countries.

© 2015 Google Inc. All rights reserved. Google Maps™ mapping service is a trademark of Google Inc.

Windows is a registered trademark of Microsoft Corporation in the United States and other countries.

NEXTBASE Replay 3™ is a registered trademark of Portable Multimedia LTD in the United Kingdom.

NEXTBASE Cam Viewer™ is a registered trademark of Portable Multimedia LTD in the United Kingdom.





microSD™ and the microSD logo are trademarks of SD-3C, LLC.

Wi-Fi® is a registered mark of Wi-Fi Alliance Corporation.

Other trademarks and trade names are those of their respective owners.

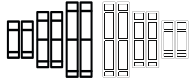
PACKAGE CONTENTS

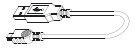
Please check the contents of your NEXTBASE product.

Dash Cam 	Fitting Straps  3x black sets / 3x clear sets	Car Power Cable 	USB Cable 
Window Sticker 	Quick Start Guide 		

Product appearance may differ slightly to that shown above.

PRODUCT FEATURES

Thank you for purchasing this NEXTBASE Dash Cam, in this section we will outline some of the features available with this Dash Cam.

4.0" HD LCD Colour Screen

The screen is used for playback of the recorded video files and settings adjustment. The screen is hidden from view behind the Mirror during normal use.

GPS Logger

GPS co-ordinates, date and time are recorded, the journey can then be viewed using the supplied Windows & Mac playback software.

The software is also available to download from www.nextbase.com

Wi-Fi Connectivity

Connect your smartphone or tablet device to the Dash Cam, can be used to Start/Stop recording or to view or download files from the Dash Cam.

G Sensor / File Protection

In the event of an impact the device will automatically 'protect' the recording, stopping the file from being over-written. This can also be performed manually, by pressing the 'protect' button.

Individual files can also be 'protected' when viewed within playback mode.

Intelligent Parking Mode

Once enabled, Parking Mode will put the Dash Cam in to standby mode after 5 minutes of inactivity. The Dash Cam will power on automatically and record 2 minutes of video, when physical movement of your vehicle is detected.

PARTS & CONTROLS

Please see below to identify the parts and controls of your Dash Cam.

Front:

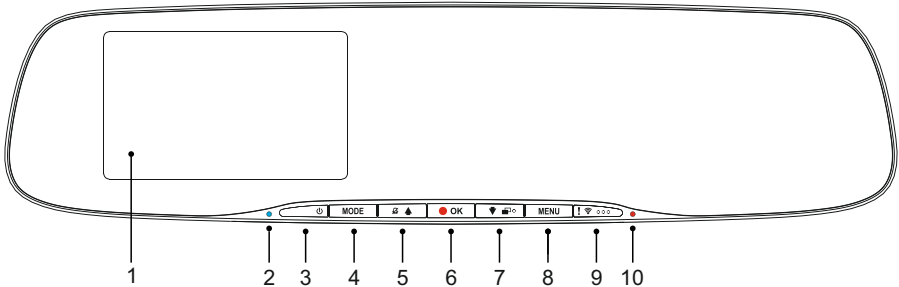

- 1. Screen**
4.0" LCD colour screen for the viewing of recorded files on the Dash Cam.
- 2. Battery Charging LED Indicator**
The blue LED will be seen when the battery is charging, this will only occur when power is connected to the Dash Cam.
- 3. Power On / Off**
Press and hold for 2 seconds to turn on / off the Dash Cam.
- 4. Mode**
Press to change between video, photo or playback modes.
- 5. Up / Microphone Off**
Up:
Press to navigate up within menus and to move to the previous file when in playback mode.

Microphone Off:
Press to turn off / on the microphone (audio recording), only available whilst in video mode.
- 6. Record / OK**
Record:
Press to start or stop a recording when in video mode, or take a photo when in photo mode.

OK:
Press to confirm selection when in menus.

PARTS & CONTROLS (CONTD.)

Continued from previous page.

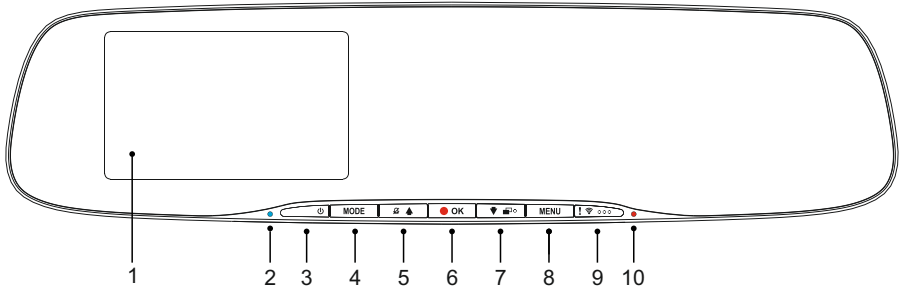

7. Down / Screen Off,On

Down:

Press to navigate down within menus and to move to the next file when in playback mode.

Screen Off:

Press to turn Off / On the screen, only available whilst in video mode.

Note:

- To help locate the Screen Off/On button, there is a 'pip' on the button.

8. Menu

Press to open the menu within current mode, press twice to open the Setup menu.

9. Protect File / Wi-Fi

Protect File:

Press whilst recording to protect the current file in event of an emergency situation.

Note:

- To help locate the Protect button, there are three 'pips' on the button.

- A marker will be seen on the recorded file, noting when the protection took place.

Wi-Fi:

Press and hold for three seconds to turn on Wi-Fi mode, this is not available whilst recording or during playback.

Note:

- To exit Wi-Fi mode please press the MODE button.

10. Recording LED Indicator

The red LED will be seen when the Dash Cam is turned on, during recording the LED will flash.

PARTS & CONTROLS (CONTD.)

Back:

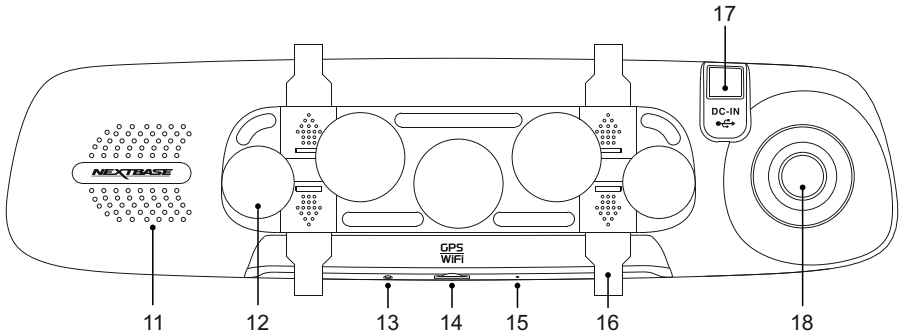

11. Speaker

Integral speaker for audio playback directly from the Dash Cam.

12. Suction Cups

Used to attach the Dash Cam to the vehicles existing rear-view mirror.

13. Reset button

In the unlikely event the Dash Cam becomes unresponsive, press the RESET button to restart the Dash Cam.

14. MicroSD Card slot

Insert the MicroSD card here, taking care that the gold contacts are facing towards the LCD screen side of the Dash Cam. Push the memory card until it clicks into place.

15. Microphone

Integral microphone for audio recording.

16. Strap Retaining Hooks

Attach the silicon straps here to secure the Dash Cam to the vehicles existing rear-view mirror, if required.

Note:

- The hooks and covers can be removed by simply sliding the cover in the direction of the arrow.

17. DC-IN & USB socket

Connect the supplied car power cable or USB data cable here.

18. Camera lens

Wide Angle 140°, 6 Element glass lens for optimum picture quality.

IN VEHICLE INSTALLATION

Please follow the instructions below for first-time installation of the Dash Cam.

The Mirror Dash Cam is designed to be fitted to the existing Rear-View mirror using the Unique sucker mount.

The straps are provided as additional security, however they don't necessarily need to be used and the four hooks can be removed completely. To remove the hooks, slide the hook cover in the direction of the arrow to disengage and then remove the hook. Replace the hook cover by sliding back in to place. If the straps are NOT to be used, please ignore step 4 in the installation instructions below.

Step 1: Insert memory card

Insert a suitable MicroSD card (Class 10, 48/Mbps) in to the Dash Cam, taking care that the gold contacts are facing towards the LCD screen side of the Dash Cam. Push the memory card until it clicks into place.

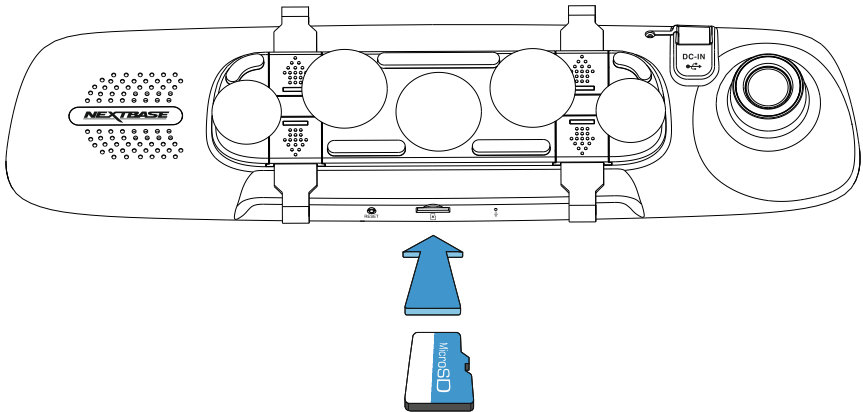

Note:

- Use the edge of a small coin (or similar object) to push the memory card in place if required. Take care that card has 'clicked' into place, a second push inwards will release the memory card.
- Do not remove or insert the memory card when the Dash Cam is turned on. This may damage the memory card.
- Take care when removing the SD card from the Dash Cam when it is installed in the vehicle. Due to the card slot mechanism the card will spring from the slot when released.

Step 2: Clean rear-view mirror

Ensure the vehicles existing rear-view mirror is clean and free of grease or dirt; this is so the Dash Cam suckers achieve maximum grip.

IN VEHICLE INSTALLATION (CONTD.)

Step 3: Attach the Dash Cam to the vehicles existing rear-view mirror

Holding the plastic edges of the Dash Cam place it onto the vehicle's rear-view mirror. Take care that all five suckers are placed onto the rear-view mirror's glass, not sitting upon the plastic edge of the rear-view mirror. Also take care that the Dash Cam lens support is clear of the edge of the existing rear-view mirror.

Once you are happy with the placement carefully push the Dash Cam onto the rear-view mirror, do NOT push directly on the Dash Cam's glass.

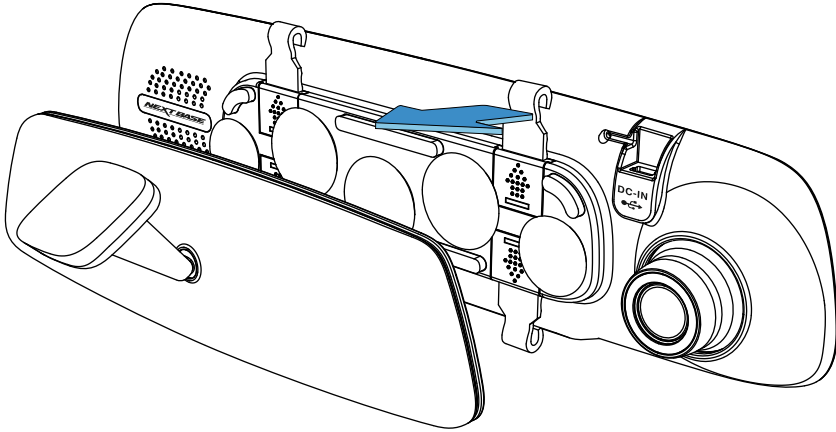

Note:

- Do not use excessive force when pushing the Dash Cam onto the vehicle's rear-view mirror.

IN VEHICLE INSTALLATION (CONTD.)

Step 4: Select & Attach straps

There are six sets of straps supplied with the Dash Cam, three sets of black material and three sets of clear material. Choose the best colour to suit the interior of your vehicles cabin.

Straps are of three different lengths: short (68mm), medium (101mm) and long (135mm). The straps have been designed so they can be cut down to give further size options, as required.

Select the size to best suit your vehicle's rear-view mirror. Attach the upper end of the straps to the retaining hooks on the top of the rear-view mirror, then extend the straps around the back of the rear-view mirror and attach them to the bottom retaining hooks.

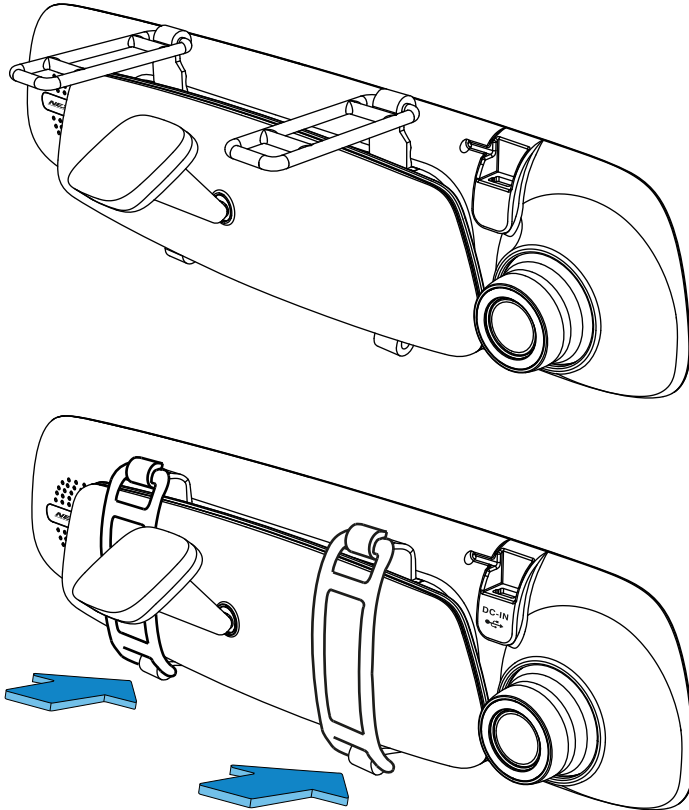

If unsure which size to use, select the medium sized straps as a starting point and change to another size if required. The straps are of high quality silicon material and can stretch twice the original length. The straps should be a tight fit when fitted, thus ensuring the Dash Cam is securely fitted to the existing rear-view mirror.

Note:

- If there is noticeable vibration seen upon the Dash Cam, try using the smaller straps which will give a tighter fit to the vehicle's rear-view mirror.

IN VEHICLE INSTALLATION (CONTD.)

Step 5: Route cable and connect power

Plug the supplied car power cable into the 12-24Vdc outlet of your vehicle and then connect the Mini USB plug to the Dash Cam.

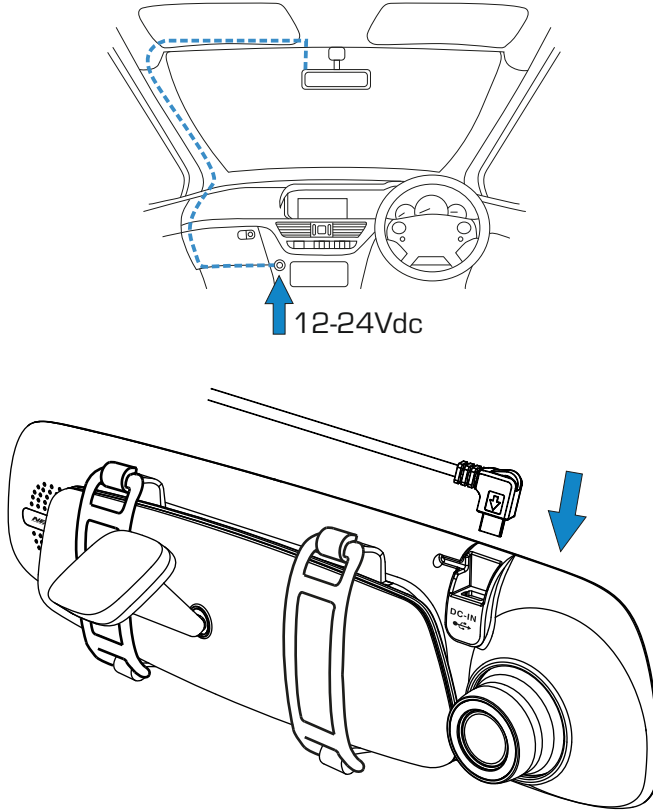

The Dash Cam will automatically power on and start recording once power is available.

In some vehicles this will be when connections are made, for others the Dash Cam will power on once the ignition has been turned on.

Should your vehicle not have a 12-24Vdc outlet, but does have a 5Vdc USB Outlet, this can be used instead, as long as it is a power only USB socket and not part of a media player. Connect the USB cable supplied with your Dash Cam in place of the car power cable. If the Dash Cam display shows "PC Connection", then the vehicles USB connection is Media Player and is unsuitable.

IN VEHICLE INSTALLATION (CONTD.)

Step 5: How to remove the Dash Cam

Typically there is no need to remove the Dash Cam from the vehicle, as recordings can be viewed via the CAM Viewer App or by removing the SD card from the Dash Cam using it directly with your PC.

However, should you wish to remove the Dash Cam then remove the straps and move the Dash Cam upwards to release it from the suckers. The suckers can then be easily removed from the rear-view mirror by using the lifting tab to break the suction.

Note:

- Do NOT wire the Dash Cam directly to a 12V supply by cutting the cigarette plug off the end of the cable, or damage will result.
- A Nextbase hardwire kit is available from your retailer. This connects directly to the vehicle fusebox and hence leaves your cigarette socket available for Phone / Sat Nav charging. The Nextbase hardwire kit includes the necessary 12-24VDC to 5Vdc convertor and battery protection circuitry.
- If a USB cable is used to power the Dash Cam and the Dash Cam starts up straight in to the PC Connection screen showing Mass Storage, Power On and Update, then the Dash Cam has detected that it has been connected to a computer and not just a simple USB power supply. A simple "Power ONLY" USB cable is required in this situation. Contact Nextbase Product Support for further assistance.

FIRST TIME USE

To ensure the set up of this Dash Cam is as quick and simple as possible, there is an easy to follow 'First Time Use' menu.

This menu is used to set your preferred Language, Country (this defines your time zone) and speed units.

The menu is available when -

- 1) The Dash Cam is first turned on.
- 2) There has been a Firmware update applied to the Dash Cam.
- 3) After the Dash Cams settings have been reset, by using the 'Defaults Settings' option within the Setup Menu.

Simply follow the on screen instructions to select the Language, Country and Speed Units. The settings that influence the displayed time & date will be applied upon receiving a GPS connection.

Note:

- Whilst the First Time Use menus adjust the settings within the Dash Cam, the settings can still be adjusted thereafter, by using the normal Setup Menu options. Changing country location is one such example of a change you could make, after the First Time Use setup.

VIDEO MODE

The key below explains the various information displayed on the screen when your Dash Cam is in Video mode, some icons will only be displayed once the relevant function has been selected within the Video menu, as described below.

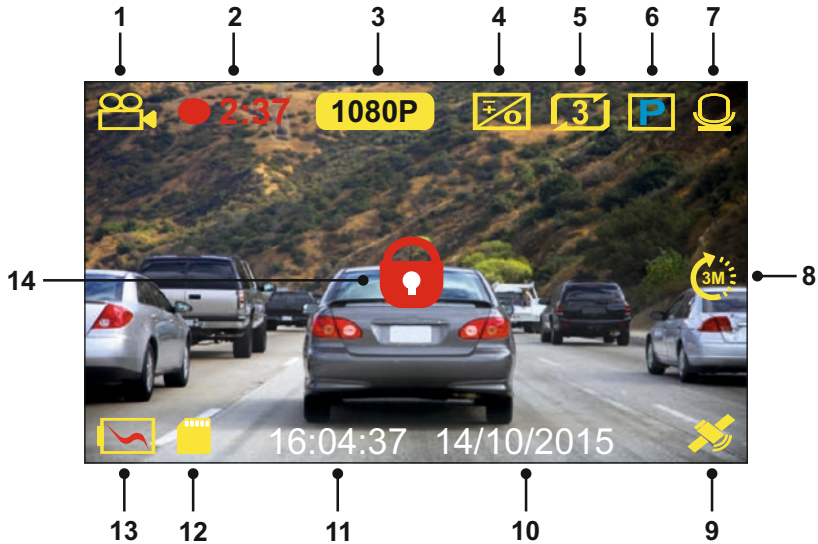

1. Mode: indicates the Dash Cam is in Video mode.
2. Recording: appears on screen when recording is in progress.
3. Resolution: displays the current resolution of the high resolution file.
4. Exposure: displays current Exposure level setting.
5. Video Length: displays the length of the individual recordings in minutes.
6. Parking Mode: appears on screen when Parking Mode has been turned on.
7. Microphone: displayed on screen when Audio Recording is active.
8. Time Lapse: appears on screen during Time Lapse recording.
9. GPS: The satellite icon will flash whilst the Dash Cam locates satellites. Once a stable signal is received, the icon will stop flashing and remain on screen.
10. Date: current date.
11. Time: current time.
12. Memory Card: indicates whether a memory card is present.
13. Battery: indicates whether Dash Cam is running on battery or external power.
14. Protected: shown on screen when a video file has been protected by activation of the G Sensor or by the pressing of the file protect button.

The default settings within the Dash Cam have been set to allow you to use the Dash Cam without the need to change any settings.

See the next page for video menu settings, should you want to make any adjustments however.

VIDEO MODE (CONTD.)

Video Menu

The Video Menu is accessed by pressing the MENU button whilst in video mode.

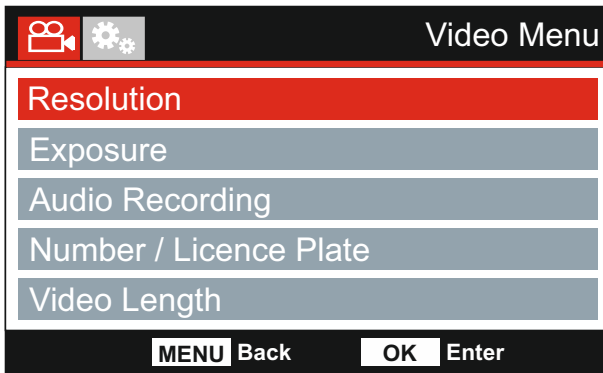

The default settings have been carefully selected to allow you to use the Dash Cam without the need to change any settings. However, should you wish to change a setting then please see below.

Use the up and down buttons to highlight the function that you'd like to change and press the OK button to enter the settings sub-menu.

Once in the sub-menu, use the up and down buttons to highlight the required setting and then press OK to confirm your selection and return to the Video Menu.

Press the MENU button twice to return to video mode.

Note:

- Menus are not accessible whilst the Dash Cam is recording.

1. Resolution

Select recording resolution of the High resolution file, this will increase or decrease the quality of the recorded video.

Options: 1080P, 720P and 720P 60FPS

Default Setting: 1080P

2. Exposure

Adjust exposure level for different light conditions.

Options: +2, +1, 0, -1 and -2

Default Setting: 0

VIDEO MODE (CONTD.)

Continued from previous page.

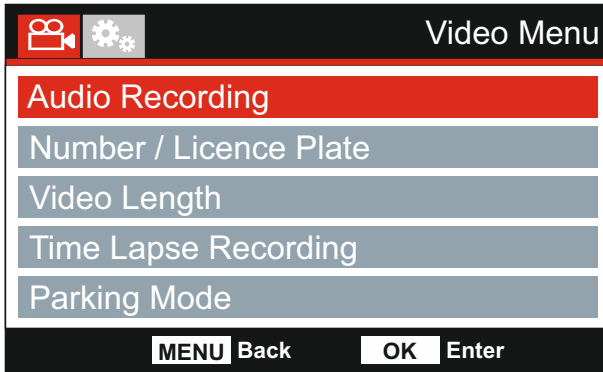

3. Audio Recording

Turn On / Off the microphone.

Options: On and Off

Default Setting: On

4. Number / Licence Plate

Enter the registration number for your vehicle, this will then be shown on the video file.

5. Video Length

Select the duration of the individual recorded video files. The Dash Cam will continue recording, filling the memory card. When the memory card becomes full, the oldest file will be automatically deleted to make space for the new recording.

Note:

- Protected files will never be deleted.

Options: 2 Minutes, 3 Minutes and 5 Minutes

Default Setting: 3 Minutes

VIDEO MODE (CONTD.)

Continued from previous page.

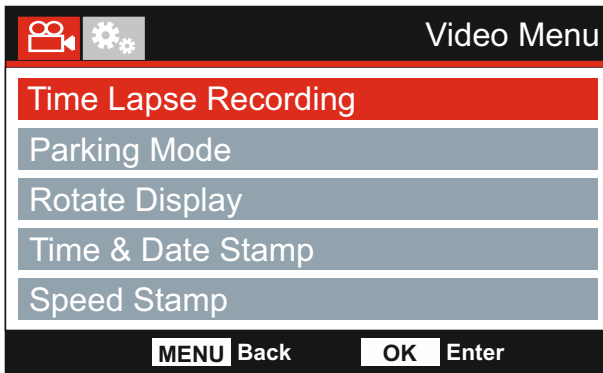

6. Time Lapse Recording

Time Lapse recording is a technique whereby the frequency at which file frames are captured (frame rate) is lower than that used when playing back the recording.

Time Lapse recording can be considered the opposite of slow motion, as when the recording is played back time appears to be moving faster.

For example, a recording taken over three minutes would be played back as a 30 second movie.

Options: 3 Minutes, 2 Hours and Off
Default Setting: Off

Note:

- It is recommended to use a high-capacity SD Card (min 32GB) for Time Lapse recording.
- Time lapse is considered as a leisure activity setting and not for use in order to collect evidence in the case of an incident / accident. Time Lapse should be turned off for normal driving conditions.
- The options of 3 Minutes and 2 Hours are the recording durations, NOT the playback time. Playback time will be 1/6th of the live recording time.

7. Parking Mode

When Parking Mode has been turned on, the Dash Cam enters standby mode when the 12Vdc supply has been turned OFF (typically removing your ignition key).

The Dash Cam will also enter standby mode if no physical movement is detected for 5 minutes, this is designed to allow use of a permanent 12Vdc supply, i.e hard-wire kit.

Should physical movement of the vehicle be detected, the Dash Cam will power on and start recording a 2 minute protected video. If no further physical movement is detected then the Dash Cam will return to standby mode, if physical movement is detected subsequently, then the camera will continue to record normally, i.e. driving once more.

Options: On and Off
Default Setting: Off

VIDEO MODE (CONTD.)

Continued from previous page.

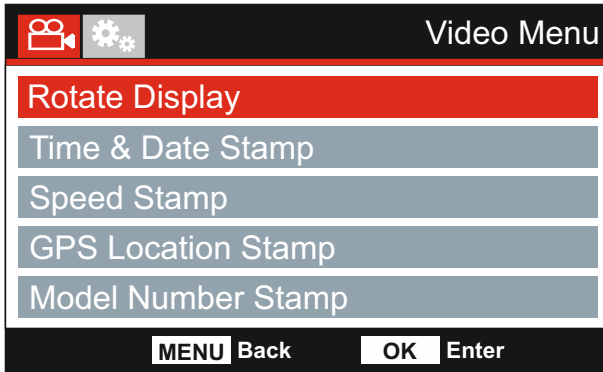

8. Rotate Display

Rotate the display 180°, particularly useful should the Dash Cam be mounted on the dashboard, the Dash Cam control button functions do not rotate.

9. Time & Date Stamp

Turn On / Off the time and date stamp shown on recorded files.

Options: On and Off
Default Setting: On

10. Speed Stamp

Turn On / Off the Speed Stamp shown on recorded files.

Options: On and Off
Default Setting: On

11. GPS Location Stamp

Turn On / Off both the GPS co-ordinates and speed stamp that are shown on recorded files. When a recording is viewed using the supplied NEXTBASE Replay playback software both the GPS co-ordinates and speed information remains available.

Options: On and Off
Default Setting: On

12. Model Number Stamp

Turn On / Off the Model Number stamp shown in the bottom left corner of recorded files.

Options: On and Off
Default Setting: On

VIDEO MODE (CONTD.)

Continued from previous page.

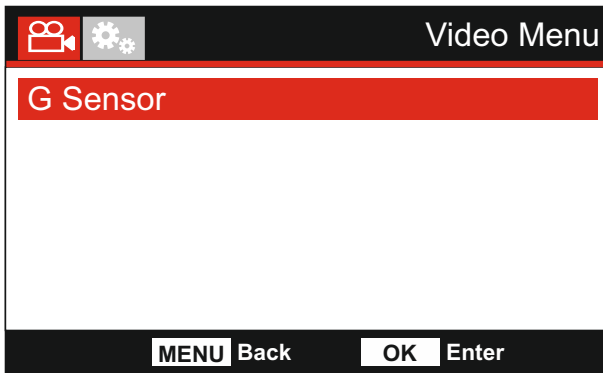

13. G Sensor

Turn Off or adjust the sensitivity of the built in G Sensor. The G Sensor detects forces which will automatically protect the current recording in event of a collision.

Note:

- This does not affect Parking mode sensitivity.

Options: High, Medium, Low and Off

Default Setting: Medium

Note:

- Within the Setup Menu which is accessed by pressing the MENU button twice, there is a 'Default Settings' option to allow you to reset the Dash Cam to the factory defaults, if required.

PHOTO MODE

Press the MODE button to select Photo mode.

The key below explains the information displayed on the screen when your Dash Cam is in Photo mode.



1. Mode: indicates the Dash Cam is in Photo mode.
2. Exposure: displays current exposure level setting.
3. Date: current date.
4. Time: current time.
5. Memory Card: indicates whether a memory card is present.
6. Battery: indicates whether Dash Cam is running on battery or external power.

See the next page for photo menu settings.

PHOTO MODE (CONTD.)

Photo Menu

The Photo Menu is accessed by pressing the MENU button whilst in photo mode.

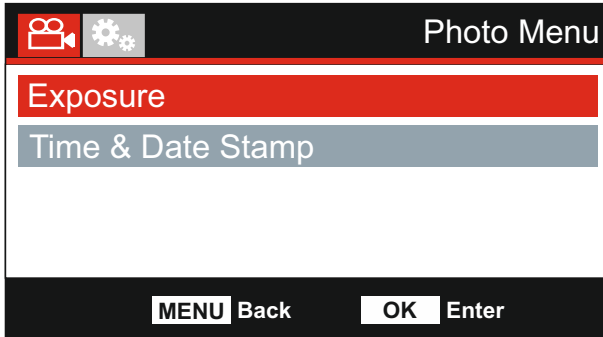

The default settings have been carefully selected to allow you to use the Dash Cam without the need to change any settings. However, should you wish to change a setting then please see below.

Use the up and down buttons to highlight the function that you'd like to change and press the OK button to enter the settings sub-menu.

Once in the sub-menu, use the up and down buttons to highlight the required setting and then press OK to confirm your selection and return to the Photo Menu.

Press the MENU button twice to return to photo mode.

1. **Exposure**

Adjust exposure level for different light conditions.

Options: +2, +1, 0, -1 and -2

Default Setting: 0

2. **Time & Date Stamp**

Turn On / Off the time and date stamp shown on images.

Options: On and Off

Default Setting: On

Note:

- Within the Setup Menu which is accessed by pressing the MENU button twice, there is a 'Default Settings' option to allow you to reset the Dash Cam to the factory defaults, if required.

PLAYBACK MODE

Press the MODE button to select Playback mode, the Dash Cam will display the last recorded file.





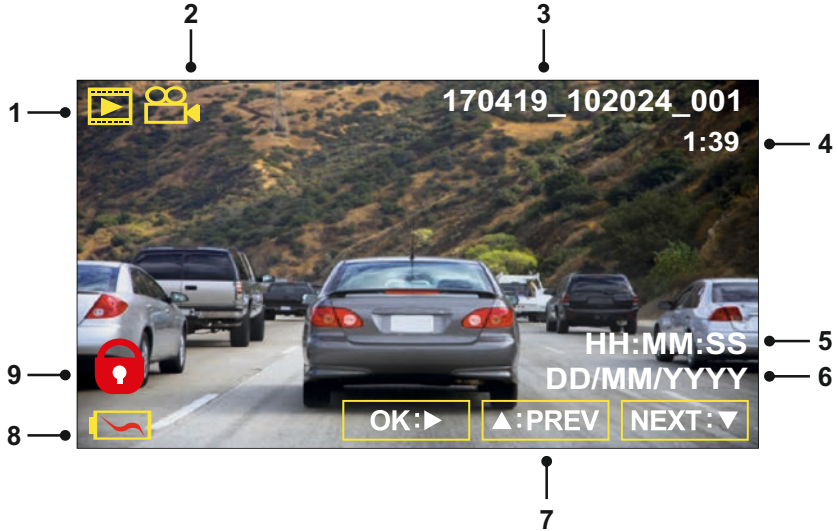

Dependent on the type of file, the on-screen information and playback functions differ.

Video Files:



1. Mode: indicates the Dash Cam is in Playback mode.
2. File type: indicates whether a video or photo file is being viewed.
3. File number: displays current file number.
4. Elapsed time: Displays the elapsed time for the video being watched.
5. Time: displays the start time that the current file was recorded.
6. Date: displays date that the current file was recorded.
7. Playback controls: use the Dash Cam buttons as described below.
8. Battery: indicates whether Dash Cam is running on battery or external power.
9. Protected file: indicates that the video file is protected.

Playback Controls:

-  Press the OK button to play / pause playback.
-  Press the MODE button to stop playback.
-  Use the UP button to select the previous file, this is only available once playback has been stopped.
-  During playback press the UP button to rewind, press the DOWN button to cancel.
-  Use the DOWN button to select the next file, this is only available once playback has been stopped.
-  During playback press the DOWN button to fast forward, press the UP button to cancel.

PLAYBACK MODE

Photo Files:



1. Mode: indicates the Dash Cam is in Playback mode.
2. File type: indicates whether a video or photo file is being viewed.
3. File number: displays current file number.
4. Time: displays the time that the current image was taken.
5. Date: displays the date that the current image was taken.
6. Next: press the down button to move to next file.
7. Previous: press the up button to move to previous file.
8. Battery: indicates whether Dash Cam is running on battery or external power.
9. Protected file: indicates that the video file is protected.

Within Playback mode there are options available to Delete and Protect files, press the MENU button to access the Playback Menu.

See following pages for details.

PLAYBACK MODE (CONTD.)

Deleting files:

Highlight the Delete Files option and press the OK button.

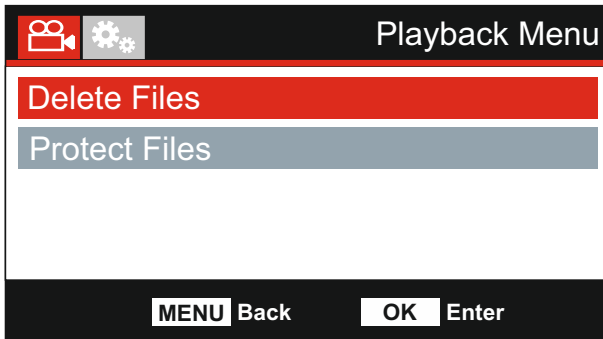

This will then give you two options:

Delete File

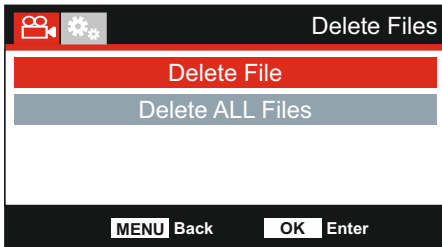

Once selected, follow the on screen instructions to delete the current file.

Delete ALL Files

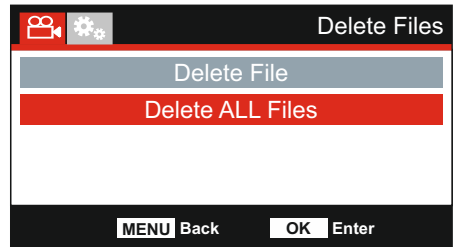

Once selected, follow the on screen instructions to delete all files.

Note:

- Protected files cannot be deleted.

PLAYBACK MODE (CONTD.)

Protecting files:

Highlight the Protect Files option and press the OK button.

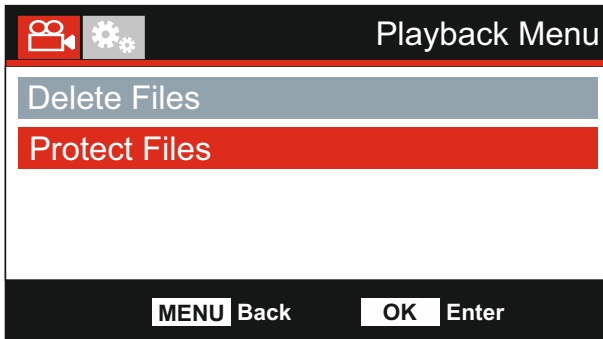

This will then give you two options:

Protect File

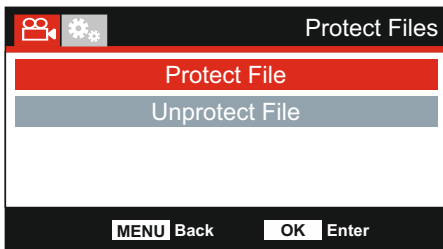

Once selected, follow the on screen instructions to Protect the current file

Unprotect File

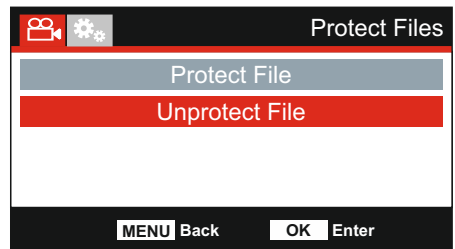

Once selected, follow the on screen instructions to Unprotect the current file.

Note:

- The 'Protect' button can also be used to Protect files when in Playback Mode.

SETUP MENU

Setup Menu

The Setup Menu is accessed by pressing the MENU button twice.

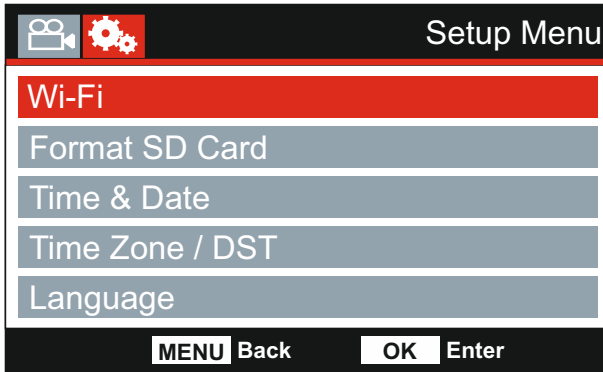

The default settings have been carefully selected to allow you to use the Dash Cam without the need to change any settings. However, should you wish to change a setting then please see below.

Use the up and down buttons to highlight the function that you'd like to change and press the OK button to enter the settings sub-menu.

Once in the sub-menu, use the up and down buttons to highlight the required setting and then press OK to confirm your selection and return to the Photo Menu.

Press the MENU button twice to return to video mode.

1. **Wi-Fi**

The Wi-Fi function allows you to use your smartphone or tablet device to view recordings directly from the Dash Cam.

2. **Format SD Card**

Format the inserted memory card, this will delete all content.

Note:

- For stable performance, it is recommended that you format the memory card every 2-3 weeks.

Of course, you should only do this AFTER you've downloaded any files from the card that you may want to keep.

3. **Time & Date**

Adjust the time / date as required using the OK button to toggle through the fields and use the up & down buttons to set variables. Press MENU to exit and return to the Setup Menu.

4. **Time Zone / DST**

The Time and Date are automatically set based on the Country selected from within the First Time Use menu.

The Time Zone / DST options are used should you want to manually select a Time Zone that falls outside of the available Country options.

SETUP MENU (CONTD.)

Continued from previous page.

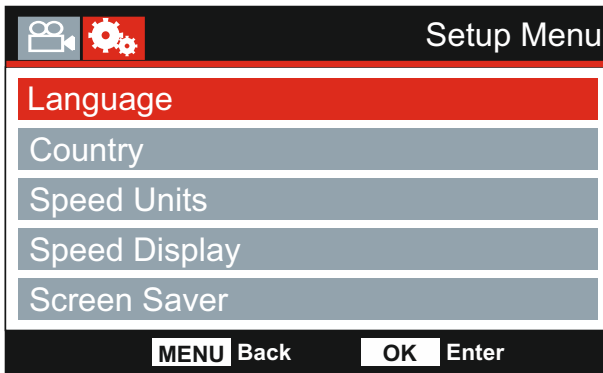

5. **Language**

Select preferred language.

Options: English, Danish, German, Spanish, French, Italian, Dutch, Norwegian, Finnish and Swedish

Default Setting: English

6. **Country**

Select your current Country, this will then automatically adjust the Time Zone / DST setting to your Time Zone, i.e. if France is selected the Time Zone will become GMT +1.

If your required Country is not available, select 'Other'. This will take you to the 'Time Zone / DST' menu, from there you can manually select your Time Zone.

Options: UK & Ireland, Belgium, Denmark, Finland, France, Germany, Italy, Netherlands, Norway, Poland, Spain, Sweden, USA, Canada, Mexico and Other
Default Setting: UK & Ireland

7. **Speed Units**

Select whether to record and display speed in KMH or MPH.

Options: KMH and MPH
Default Setting: MPH

8. **Speed Display**

When turned on, the screen will display current speed after 30 seconds of button inactivity, press any button to return to normal viewing, this function is only available when a GPS connection is present.

Options: On and Off
Default Setting: Off

SETUP MENU (CONTD.)

Continued from previous page.

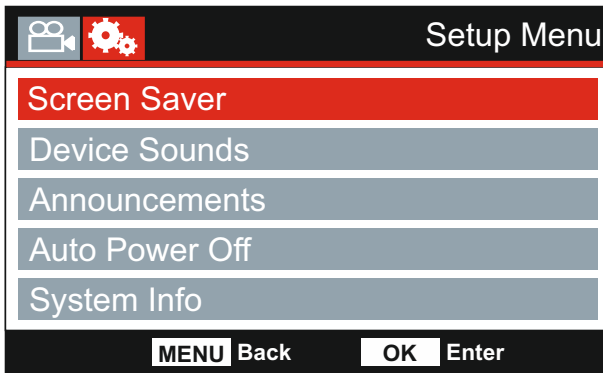

9. Screen Saver

Turn on the Screen Saver function to shut down the screen after 30 seconds of button inactivity, press any button to re-activate the display.

Note:

- If the Speed Display function has been turned on, then Screen Saver will not be available.

Options: On and Off

Default Setting: Off

10. Device Sounds

Turn Off / On the beep sound which is heard when a button is pressed and also mute the startup and shutdown chimes.

Options: On and Off

Default Setting: On

11. Announcements

Turn Off / On the spoken Announcements.

The spoken announcements provide an audible confirmation of the button that has been pressed and its function. The announcements also serve as positive confirmation after a file has been protected due to G-Sensor activation during recording.

Options: On and Off

Default Setting: Off

Note:

- Announcements are currently only available in English.

- Turning on Announcements will turn off the Device Sounds.

SETUP MENU (CONTD.)

Continued from previous page.

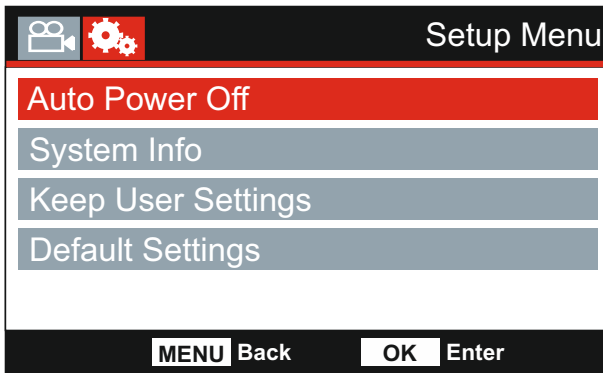

12. Auto Power Off

Adjust the timing of the Auto Power Off function, this can be used to continue recording in event of loss of power within the vehicle.

Options: 10 Seconds, 1 Minute and 2 Minutes

Default Setting: 10 Seconds

13. System Info

This covers multiple screens (pages), press OK to scroll down as required.

The model number and installed Firmware version of your Dash Cam is displayed here.

FCC-ID is shown here under the E-Label Act (USA).

SD Card Information is provided for the installed SD card within the Dash Cam

Wi-Fi Information is provided for the Dash Cam. The SSID (network name), Password and MAC address.

14. Keep User Settings

Turn this to ON in order to keep your individual user settings during the Dash Cam Update process.

Select OFF in order to clear all user settings and return them to defaults, during the Update process.

Options: On and Off

Default Setting: Off

15. Default Settings

Reset the Dash Cam to the default settings.

PC CONNECTION

Use the supplied USB cable to connect the Dash Cam directly to your PC via the  socket.

Once connected the Dash Cam will turn on with three options available, as described below.

- Mass Storage
- Power On
- Update

Use the UP and DOWN buttons to select required function and press OK to confirm selection.

Mass Storage (Windows)

When this option is selected, the Dash Cam will function as a card reader for your PC. An extra drive will appear, e.g. Removable Disk (D:) and you will be able to view / manage the stored files upon the MicroSD card within the Dash Cam.

Mass Storage (Mac)

When this option is selected, the Dash Cam will function as a card reader for your MAC. The Dash Cam will be seen as an external disk upon your MAC and you will be able to view and/or manage stored files.

Note:

- The Dash Cam is a 'read-only' device, therefore uploading files to the SD card when in Mass Storage mode is not possible.
- ALWAYS turn Off the Dash Cam before disconnecting from your computer.

Power On (Windows & Mac)

When this option is selected, the Dash Cam will power on with all functions available. This includes charging of the internal battery, a full charge will take approximately 2 hours.

Note:

- ALWAYS turn Off the Dash Cam before disconnecting from your computer.

Update (Windows and Mac)

When this option is selected, it is for use with the NEXTBASE Replay 3 Playback software in order to update the Firmware within the Dash Cam to the latest version.

Please see details within the NEXTBASE Replay 3 Playback software for more information.

Wi-Fi CONNECTION

The Mirror dash cam can share the files on the SD card with a mobile phone or tablet (minimum operating system requires Android 5.1 or above and iOS 10.3 or above) using the **Cam Viewer App**.

The App can be downloaded from the Google Play store (Android) or the Apple App store (iOS).

The Wi-Fi mode can be accessed when the camera has stopped recording by pressing the red exclamation mark button when in video mode, button 9 (page 9), for 3 seconds. Then go into the Wi-Fi settings on the mobile device and connect to the Dash Cams Wi-Fi signal. Once connected you can open the Cam Viewer App and begin viewing, downloading and sharing your recorded files.

TROUBLE SHOOTING

PROBLEM	SOLUTION
The Dash Cam will not stay fixed to the mirror, using the suckers alone.	Make sure that the mirror is clean and then slightly moisten the suction cups. Apply the Dash Cam to the existing mirror making sure that the Dash Cam sits upon the flat glass of the existing mirror and is not touching the raised edge of the existing mirror.
I cannot insert the MicroSD card.	MicroSD card are very small and require delicate use. Align the card with the diagram shown upon the Dash Cam and insert the card until you feel a slight spring resistance. You now need to push the card, using your finger nail, until you hear and feel a small latch. Release pressure and the card will stay retained within the device. Use the edge of a small coin if you have difficulty.
I cannot remove the MicroSD card.	With the card previously installed, you now need to push the card further inwards slightly, using your finger nail, until you hear and feel a small latch. Use the edge of a small coin if you have difficulty. Release pressure and the card will spring out sufficiently for you to take hold of it.
I can only record a few minutes of video on my MicroSD card.	Change the recording size (Video Length function) to a smaller size. Increase the size of the MicroSD card. Max 128GB.
I cannot save files to the memory card when the Dash Cam is connected to my computer under Mass Storage mode.	Correct, the Dash Cam is a 'read-only' device. It is not recommended to save files from other sources to the same memory that you will use for recording within the Dash Cam, as these may have a negative effect on the performance of the Dash Cam.
No power to my Dash Cam, but it works upon my PC.	The cigarette power cable is not working. Inspect the fuse in the Car Power plug. Replacement fuse = 2A 20mm type. If the fuse is found to be blown, inspect the power cable for damage which may have caused the fuse blow.
My Dash Cam shuts down by itself after a while.	Either the battery has gone flat, there is no power to the Dash Cam and the Auto Power Off period has been triggered or Parking Mode has been turned on and no vehicle movement has been detected for 5 minutes.
The screen blanks after a few minutes upon my Dash Cam.	The screen saver is set to ON. Change settings to OFF if required. Default setting is off.
The battery will not charge.	Ensure the Dash Cam is connected to a reliable power source and that the supplied Car Power Cable is being used, with the Power LED lit.

TROUBLE SHOOTING (CONTD.)

PROBLEM	SOLUTION
The battery only last 30 seconds.	<p>The battery will only receive charge when the Dash Cam is connected to power, please reconnect the car adaptor or domestic USB charger and leave the Dash Cam to charge. Charging takes approximately 90 minutes and a full charge is indicated when the BLUE (charging) LED goes out.</p> <p>Take the camera indoors and charge it for 90 minutes, does the problem persist? If not... the car power supply may be causing the issue.</p>
The battery only lasts 20 minutes.	<p>This is normal, the battery design allows the 'Auto Power Off' feature to function in event of power loss within the vehicle. It is not intended as an alternative power source to replace the supplied car adaptor.</p>
The Dash Cam cannot lock onto satellite.	<p>After power on and with the device mounted with clear view of the sky it can take up to 10 minutes to find the three satellites required to achieve a stable signal. Reception can also be affected by atmospheric conditions and the proximity of buildings / trees obscuring the sky.</p>
I get the message "SD Card Error. Please format SD card" on screen.	<p>The SD card has been formatted in another device and the Cluster Size is not compatible or the SD card is formatted in ExFAT / NTFS. There may also be an error on the card. Use the Setup option to re-format the SD card from within the Dash Cam.</p>
I get the message "Card Full" on screen.	<p>The SD card has become full as there may be too many protected files which will not be deleted to allow for further recording to take place. Delete unnecessary files or perform a full FORMAT upon the SD card from within the Dash Cam Setup Menu.</p>
The SD card in my Dash Cam cannot be read.	<p>Use a good quality branded SD card between 8GB and 128GB (Class 10 or UHS type 1) and format the card from within the Setup Menu.</p>
I can't delete files on my SD card within the Dash Cam.	<p>Check to see if these files are 'protected', if so please follow instructions to 'un-protect'.</p>
Mass Storage function does not work.	<p>The Mass storage function will work on both Windows and Mac. Restart the PC, as this may be required for the necessary driver to be loaded correctly. Disconnect and reconnect the Dash Cam. Contact NEXTBASE for the required driver.</p>
Video files cannot be played.	<p>The video files from the iN CAR CAM are in .MOV format and may not be compatible with your PC if suitable playback software is not installed.</p>
Video Image is blurred.	<p>Remove the protective lens cover, clean the lens, clean the windscreen!</p>

TROUBLE SHOOTING (CONTD.)

PROBLEM	SOLUTION
Video file playback is jumpy.	Remove the SD card and reformat to remove non-contiguous files. For best recording use a quality branded class 10 type (48MB/s) or UHS type 1 micro SD card of 8 to 128GB recommended size. PC may not be sufficient for the playback task, try a different PC. Copy the recorded video files onto the PC / Mac for playback directly rather than use the Dash Cam as a card reader, as the USB system on your PC may be too slow for HD video playback. Reduce the resolution of the recording within the Dash Cam and record some new files to test if this is the problem.
The sound is not synchronised with video during playback.	The Codecs upon your PC may not be compatible or the latest standard. Download the latest Codecs from: www.nextbase.co.uk
Video has no sound.	Ensure that "Record Audio" setting is turned ON within the Video Menu of the Dash Cam.
Video playback is really quick on my PC, not consistent with the drive that was recorded.	Turn off the Time Lapse Recording, form within the Video Menu.
Photograph is blurred.	Hold the camera still whilst taking the photo. Please be aware the photo is taken around 1 second after the shutter noise is heard.
I have turned on 'Parking Mode' and now can't stop the recording.	The Dash Cam will start a recording whenever motion is detected. To turn off Parking Mode firstly shutdown the Dash Cam and remove the SD card, this will avoid recording being activated accidentally. Switch the Dash Cam On and within the Setup Menu, turn off the 'Parking Mode'.
When I get in to my car, the Dash Cam is already recording and the file is protected.	This is normal. Parking Mode has been switched on and the Dash Cam has sensed vibration and has started to record correctly. Parking mode can be turned off within the Video menu if required.
When I press the MENU button nothing happens.	This is normal during recording. Stop the recording before pressing the MENU button. If recording re-starts before you can press MENU, then see the Parking Mode section above.
The time on my Dash Cam is wrong and when I adjust the time manually, it keeps changing.	The Dash Cam sets the time based upon the country which has been selected and also whether Daylight Savings time is currently in force. Please verify the Country setting within the menu is correct. The Time Zone can be set manually, if the Dash Cam is to be used outside the listed countries in the Setup Menu.
Downloading files from www.nextbase.co.uk using Google Chrome results in a Malicious Software message.	This is not a cause for concern, simply go to the settings within Google Chrome and turn off the malicious software protection temporarily to download and install the playback software. Reinstate previous Google Chrome settings thereafter.

TROUBLE SHOOTING (CONTD.)

PROBLEM	SOLUTION
My Mobile Device will not connect to my camera.	Please ensure that you have turned the Dash Cam Wi-Fi Mode on by either using the Wi-Fi button or through the Settings Menu. When Wi-Fi Mode is turned on the screen of the Dash Cam will display the Network Name and Password. This password is case sensitive.
The NEXTBASE Cam Viewer app will not open.	Please uninstall the NEXTBASE Cam Viewer app and re-download again from your devices App Store.
When I open the NEXTBASE Cam Viewer App I get a message saying 'Please Check Device'.	Ensure that the Dash Cam is in Wi-Fi Mode and that your mobile device has connected to the Dash Cam Wi-Fi connection.
When I try to play back a file from my Dash Cam I get a message saying 'Buffering' but the video does not load.	Please restart your mobile device and reconnect to the Dash Cam Wi-Fi connection. Then re-open the Cam Viewer App.
I am unable to playback a specific video file from the SD card when using my PC.	The file may have not been closed correctly during recording. Repair may be possible by re-inserting the SD card back in to the Dash Cam, select Playback Mode and playing the affected video file.
Card full and card error message.	Is a branded card that is compatible with loop recording being used? This issue can occur if a counterfeit, slow or unbranded SD card is being used.
No mass storage option.	Try multiple USB ports and an alternative mini USB cable (if possible).
Juddering image.	This is usually caused by a PC that is not compatible with HD or Ultra HD playback, we recommend an i5 or equivalent to play the files and metadata effectively.
Unresolved issues.	Reset the Dash Cam to the Default Settings within the Setup Menu and try again. Should the problem persist call the UK helpline (02920) 866429 or call your local support centre found at www.nextbase.com Alternatively email: support@nextbase.com

NEXTBASE

www.nextbase.com



NBDVRMIRROR-IM-ENG-R4